

2

chapter

Electrical power supply

Reminder of rules, regulations and practices in order to select properly the power supply of the machine. Introduction to the power supply and control functions

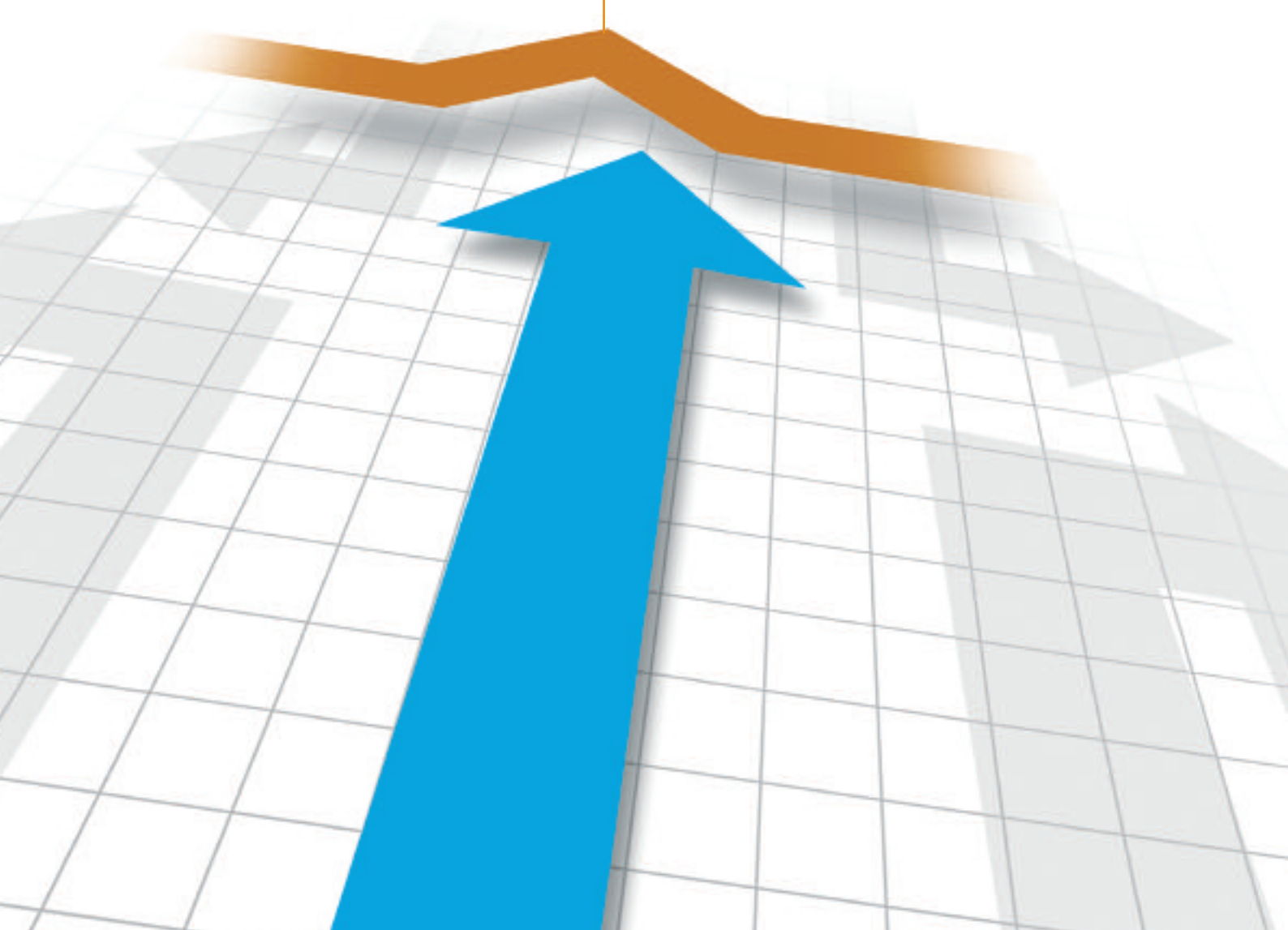

2.1	Introduction	Page	2
2.2	Power supply to machinery	Page	3
2.3	Standards and conventions	Page	4
2.4	Power supply functions	Page	5
2.5	Power supply to the control circuit	Page	6

2. Electrical power supply

- 2.1 Introduction
- 2.2 Power supply to machinery
- 2.3 Standards and conventions

2.1 Introduction

This section explains how electrical systems in machinery are supplied with electricity. A supply system acts as an interface between the mains installation and the machinery and must meet the technical standards and constraints of both (⇒ Fig. 1). It is the latter which is described here and readers are advised to refer to the *Electrical installation guide* for further information.

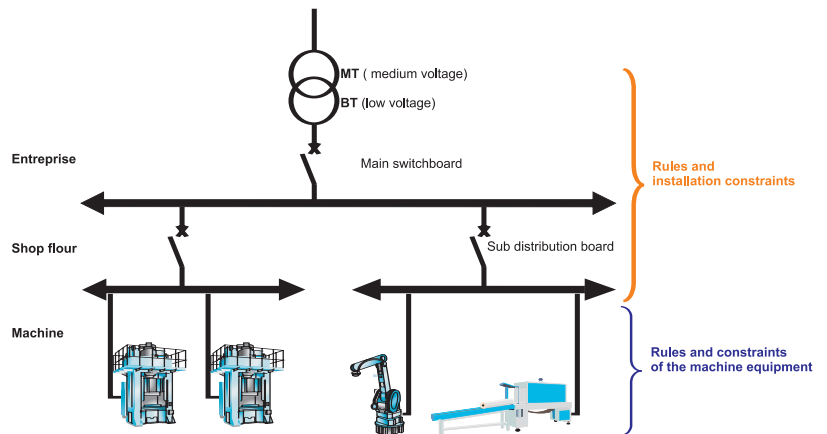

↑ Fig. 1 Electrical power supply architecture

2.2 Power supply to machinery

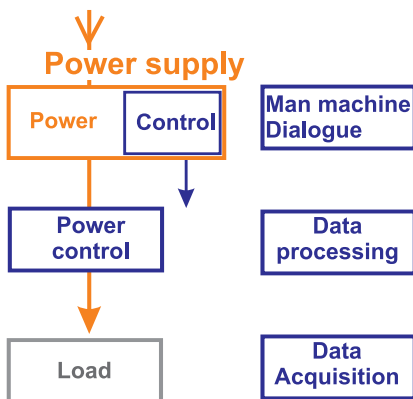

↑ Fig. 2 Power supply functions

As illustrated in the diagram (⇒ Fig. 2), an electrical power supply is divided into two units.

The power unit feeds machine loads such as motors or heating circuits via the control components (pre-actuators). Voltage usually ranges from 200V to 660V in 3-phase and 120V to 230V in single phase.

The control unit powers automation components such as contactor coils, solenoid valves, PLCs, sensors, etc. Voltage is usually low (120V to 200V in single phase) and extra low (12 to 48V).

This unit is often called the “head” and governs a set of functions described in subsection 2.4.

2.3 Standards and conventions

As we have already said, an electrical power supply is governed by constraints in two areas:

■ Electrical distribution system

Each country has its own conventions and defines its own rules. This means there are a great many different standards, such as C15-100 in France. We can however summarise the constraints and conventions regarding equipment powering devices as follows:

- mains voltage. A table of voltages per country is provided in the *Electrical installation guide* and the characteristics of public distribution networks are given in EN 50160:1999,
- neutral distribution and system earthing,
- wiring practices,
- product standards and clearance distances,
- types of fuses for fuse-holders or fused switches.

■ Machinery

Standards have been brought in line with IEC 60 204-1 to facilitate export and use the same machines through the world. Few countries have retained some specific rules; elements of the main ones are given in the table in (⇒ Fig. 3) below.

TNC diagrams are not permitted in low-voltage installations in buildings (Norway).

TT power diagrams are not permitted (USA).

The neutral conductor break is mandatory in TN-S diagrams (France and Norway).

The distribution of a neutral conductor in an IT diagram is not permitted (USA and Norway).

The maximum rated voltage of an AC control circuit is 120V (USA).

The minimum gauge of copper conductors is specified in ANSI/NFPA 79 in American sizes (AWG) (USA). Annex G of the standard gives the equivalent in mm² of the AWG.

WHITE or GREY is used to identify neutral earthed conductors instead of BLUE (USA and Canada).

Marking requirements for rating plates (USA).

↑ Fig. 3 Specific features of standards and practices in a number of countries

■ Three zones of influence

Notwithstanding the differences in standards and practices amongst countries, there are three major zones of influence: Europe, USA and Japan (⇒ Fig. 4).

	Zone of influence	USA	Europe	Japan
Electrical distribution	3-phase supply voltage	480V	400V	200V
	LV installation rules / standards	NEC	IEC 60364	JIS C 0364
Machine powering equipment standards	See differences above	IEC60204-1	IEC60204-1	JIS-B 9960
Head device	Circuit breaker	UL 489	IEC60947	JIS-C 8201-2-1
	Switch / fuses	UL98	IEC 60269 Different fuses per country	JIS-C 8269
	Motor contactors / circuit breakers	UL508	IEC 60947	JIS-C 8201-4-1
Type of upstream connection	<100A	>100A connectors	Connectors, screw brackets, elastic connections	Lug clamps
	>100A	Parallel wires	Wires with lugs or busbars	Wires with lug clamps

↑ Fig. 4 Requirements in the zones of influence

2.4 Power supply functions

There are three separate functions:

■ Supply and cut off the machine power and control units with attention to the following points

□ Break capacity

Depending on the power installed, the prospective short-circuit current in the event of an incident can range from a few kA to several hundred kA, so the device must be sized accordingly.

□ Short-circuit endurance

A short-circuit downstream of the electrical equipment must not cause destruction of the device.

□ Connection capacity

Internal wires in equipment are always in copper but it should be noted that aluminium is used in electrical system distribution. The input device should therefore withstand both types of connection.

□ Manual control and remote control on cabinet

Safety rules require direct control from the electrical cabinet to switch off or disconnect the installation.

■ Personal protection

Electrical cabinets are usually locked during operation, so operators do not have access to them. Regulations stipulate personal protection rules for working inside of electrical devices, in particular for starting and maintenance. Personal protection requires compliance with a number of rules:

- IP20 protection against contact with internal connections,
- disconnection.

This function ensures the installation is completely or partly disconnected from any source of electrical power for safety reasons.

• Insulation

Insulation must be ensured when a control device is open, i.e. the leakage current must be below the danger threshold.

• Padlocking

This function is intended to prevent any unauthorised person from switching on electrical devices.

• Control insulation

This must be adequate to protect people and electrical equipment from over-voltage and other electrical pollution.

• Equipotential connection

Installation rules can stipulate earthing or insulation according to the system earthing used.

■ Distribution network protection







Protection from incidents due to the machine must include break capacity and coordination and discrimination. An incident should never have adverse effects on the rest of the distribution system.

2. Electrical power supply

- 2.4 Power supply functions
- 2.5 Power supply to the control circuit

■ Power unit supply

The table (⇒ Fig. 5) summarises the power units and functions covering the requisite functions.

Function	Fuse holder 	Dimmer 	INS switch 	Fused switch 	Magnetic circuit-breaker 	line circuit-breaker 	Differential relay 
Disconnection	XX	XX	XX	XX	XX	XX	
Switch-off		X	XX	XX	XX	XX	
Short-circuits protection	XX			XX	X	XX	
Isulation	XX	XX	XX	XX	XX	XX	
Short-circuits immunity	X	X	XX	XX	X	XX	
Padlocking	XX	XX	XX	XX	X	XX	
Protection from earth faults						option	XX

↑ Fig. 5 Comparative device table

2.5 Power supply to the control circuit

The power supply to the control circuit is governed by regulatory and technological constraints. The need for personal protection has led to the use of extra low voltages (ELV), i.e. less than 50V. Electronic components are now widespread and require direct current to power them.

Apart from simple or specific applications which still use low voltage, DC ELV power supplies are now commonly used.

■ 24V power supplies

Here we describe different types of 24V sources. This voltage is now standard in industry and most manufacturers have extensive product ranges. Standardisation helps to limit the risk of incompatibility between products.

- **This solution has a number of benefits**
 - saving in space and equipment,
 - improved reliability and circuit-break detection available on some PLCs,
 - personal safety,
 - operating continuity ensured by backup systems or voltage drop filters,
 - no capacitive effect in wiring,
 - environmental protection due to lower electricity consumption.
- **But there are also some drawbacks**
 - low voltage limits cable length,
 - the number of contacts in series or sensors is limited,
 - caution must be taken with earth links,
 - contacts can deteriorate quickly in hostile environments (dust, chemicals, etc.),
 - there may be problems of compatibility between PLC output specifications and contactor sensors and coils. It is advised to use low-consumption contactors which are well suited to this kind of use.

■ 24V direct current technologies

Technologies have also progressed in this area. Conventional power supplies use a transformer with separate windings which convert the voltage and insulate LV from ELV. Improvements in switching technology along with lower costs make this an advantageous alternative in several ways. A description of both technologies follows.

□ Rectified power supplies

These consist of an LV/ELV transformer followed by a bridge rectifier and a filter (⇒ Fig. 6).

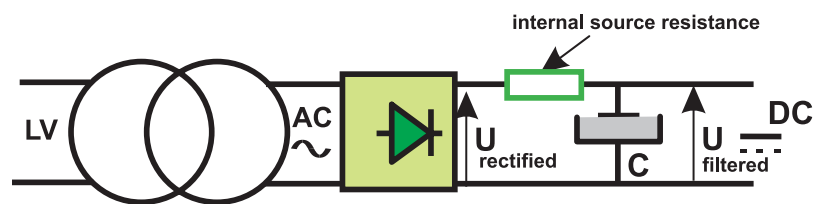

↑ Fig. 6 Working diagram of a 24V power supply

Upstream power to the transformer can be single or 3-phase; the latter (⇒ Fig. 7) dispenses with the need for smoothing capacitors. Though this solution is more reliable, its immunity to micro-breaks is lessened.

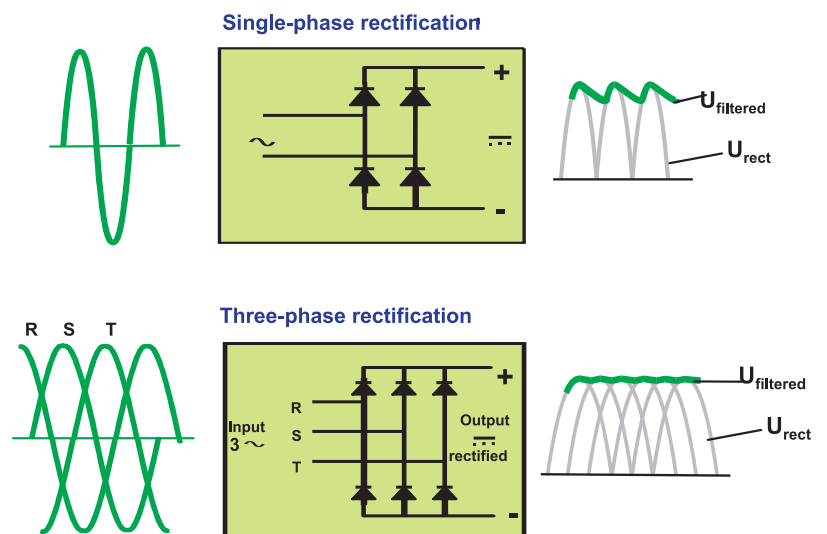

↑ Fig. 7 Single-phase and 3-phase rectification

□ **Switching power supplies** (⇒ Fig. 8)

The working principle involves switching the voltage from a rectified source to a high frequency of a few dozen to several hundred kHz. This makes possible to power a ferrite transformer with a better power weight ratio than conventional 50Hz transformers. The output is then rectified and filtered.

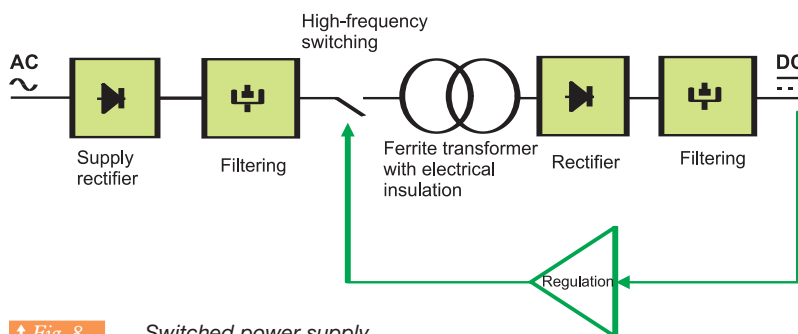

↑ Fig. 8 Switched power supply

A loop feedback controls the high-frequency switch cycle time to ensure the requisite regulation characteristic (⇒ Fig. 9).

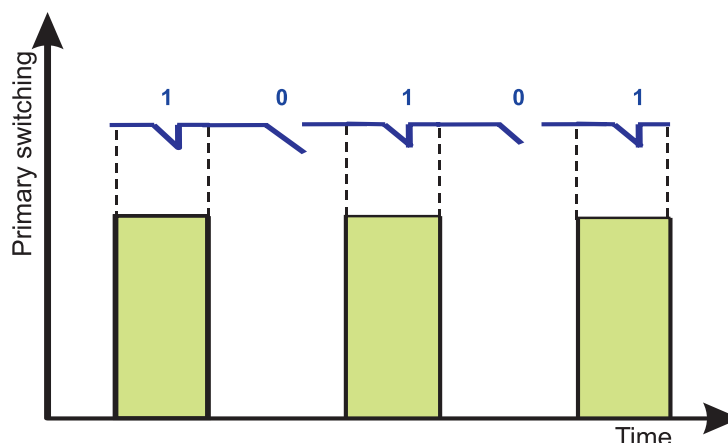

↑ Fig. 9 Principle of switched power supplies

□ **Conclusion**

The table (⇒ Fig. 10) gives a brief comparison of the two technologies. For more details, see the section on product implementation.

Comparison for a 10A/24V DC source	Regulated switched power	Rectified filtered power
Input voltage range	Wide range of 85 to 264V	Set ranges of 110V to 230V
Overall dimensions	3dm ²	7dm ²
Weight	1.5kg	6kg
Efficiency	Up to 85%	Up to 75%
Output voltage adjustment	Yes	No
Microbreak immunity	High >20ms	Low <5ms
Load regulation	1 to 3%	5%
Line regulation	<1%	5-10% depending on mains
EMC pollution	Requires careful design	Naturally low
Harmonic pollution	As per EN61000-3-2 with filter	Basically as per standard EN61000-3-2
Reliability, lifetime	Good	Very good

↑ Fig. 10 Comparison of direct current power supplies